



With high speed to top quality

Stress Screening Systems WT/WK



Weiss Umwelttechnik GmbH
Simulationsanlagen • Messtechnik



Safety first . . .

... reliable testing to guarantee safety

High product reliability is a basic requirement for today's competitive market and is often the only difference between the various manufacturers.

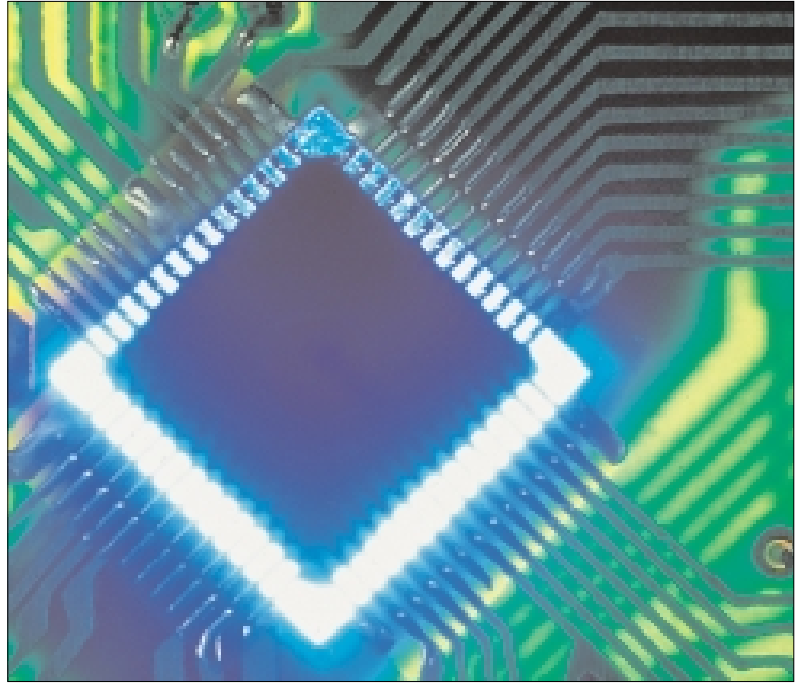



The reliability of electronic products can be substantially improved by the use of environmental stress screening (ESS) techniques to minimize the risk of errors and failures of products and simultaneously improve the reputation of a company.



ESS

What is ESS?

The test ...

During the ESS test, the products are subject to precisely defined stress so that defects in components and PCBs can be detected before leaving the manufacturer's plant. Detecting weak points considerably improves the robustness of the products. Unreliable systems are filtered out before they reach the customers.

Each product requires a specially adapted ESS technique.



The advantages of ESS are ...

- ❑ Improvement of product reliability. The products do not simply function, they operate correctly for a long period of time.
- ❑ The quality itself is substantially improved, customer satisfaction increases and the sale of reliable products likewise. Reliable products ensure that the reputation of the manufacturer on the market remains a good one.
- ❑ ESS means reduced costs as product failures do not occur during the warranty period when they are already in the possession of the customer.
- ❑ ESS reduces the risks which can occur in products due to components or processes and there is less risk involved when a new product or new technology is introduced.
- ❑ ESS means quick "feedback". Construction or process problems can be detected more rapidly which means a quicker "learning curve". Also "feedback" is obtained directly from in-house quality assurance and not via the customer.

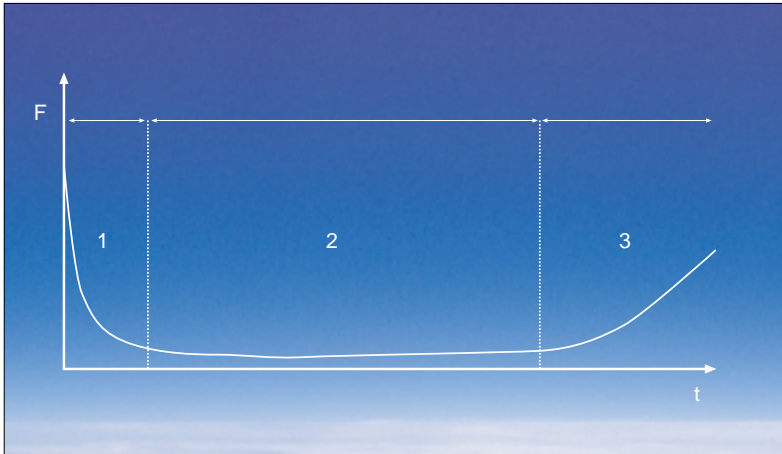

Service life curve of electronic components

ESS means that errors which normally occur during the usage phase occur in the production phase

$F = \text{error} \cdot t = \text{time}$

1 = early failures • 2 = usage phase • 3 = wear phase

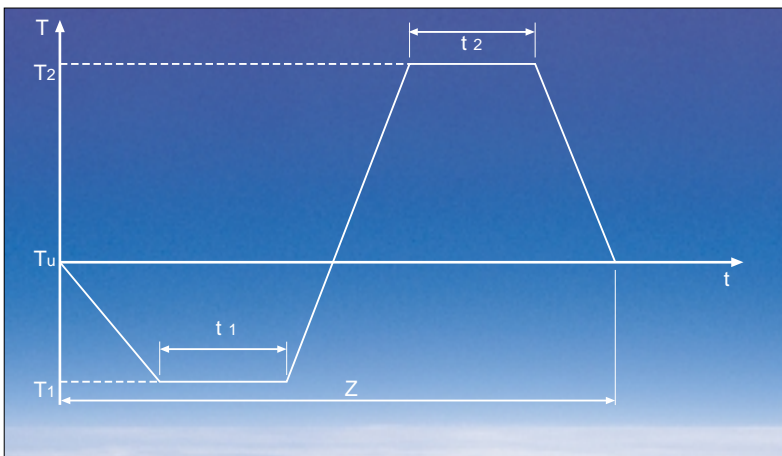

Temperature shock cycling test as per IEC 60068-2-14, Test Nb

T = temperature • T_1 = low temperature • T_2 = high temperature

T_u = ambient temperature • Z = cycle • t = time

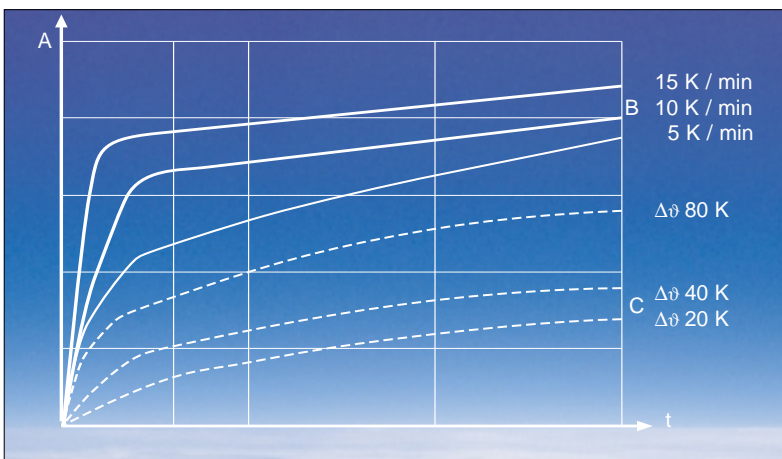

Effectiveness of thermal cycles and high temperature storage for preconditioning of circuit boards

A = effectiveness • B = thermal cycles • C = high temperature storage • t = time

$\Delta\vartheta$ = temperature increase to max. working temperature

Mode and effects ...

In practice, the following ESS methods have prevailed:

- Temperature stress
- Vibration stress
- Humidity stress

in conjunction with electrical stress. Our stress screening test cabinet series was specially designed for temperature stress. The WK series of climatic test cabinets is available for humidity stress.

Environmental stress screening on PCBs (or other products) is achieved by thermal stress with quickly changing temperatures. ESS is the most effective method of detecting poor soldering joints and SMD processes as well as manufacturing errors before delivery.

Typical ESS profiles contain a thermal change with 5...15 K/min over a wide difference in temperature (see technical data on page 10/11).

The periodic or constant switching of the boards during the thermal cycle can increase the detection of errors. The above mentioned results are achieved in special ESS chambers because the heating and cooling capacity as well as the amount of circulating air is considerably higher than that of a conventional test chamber. High amounts of circulating air improve the heat transition and ensure that the specimens and/or boards are homogeneously stressed.

Weiss Umwelttechnik has developed a range of systems especially for this purpose which does more than justice to the above mentioned requirements.

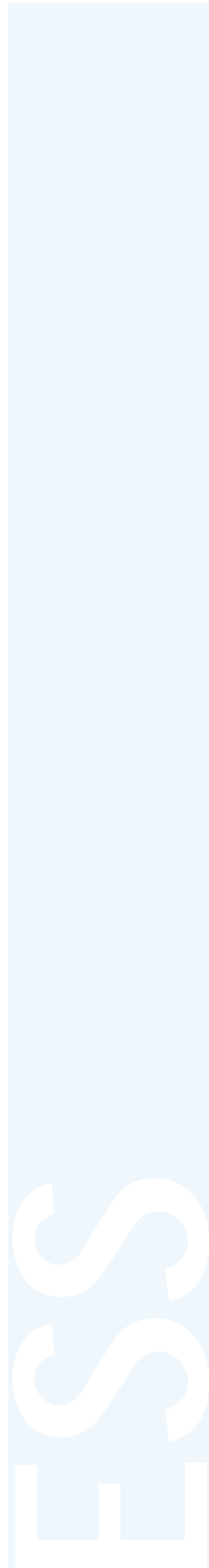

Convincing technology...

... the stress screening systems of the series WT/WK

The test systems based on the well-tried modules of the WT and WK series with increased power for heating, cooling and circulating air and test chamber volumes of 190 to 1540 litres are capable of meeting virtually all requirements. The WK series also complies with customary climatic test standards.

The technology of the systems, as is to be expected from the ergonomic design, provides optimum operation and reliable functioning:

- Powerful, homogeneous temperature and/or climate conditioning of the test chamber.
- The specimens are protected by an independent temperature measurement.
- The humidity sensor of the WK series is self-cleaning.
- Optimized air ductwork for all test chamber volumes.
- Touch panel with simple, menu-guided operation – no programming knowledge required.
- 32 bit processor
- Easily accessible maintenance elements ensure minimum service times for the condenser, water bath and humidity sensor.
- Automatic water replenishment without interrupting operation with large storage tank for the WK series.
- Environmentally friendly, high-quality insulation.
- Easy-to-clean test chambers thanks to special welding and molded racks.
- Tightly sealed and easy-to-clean surfaces thanks to powder coating.

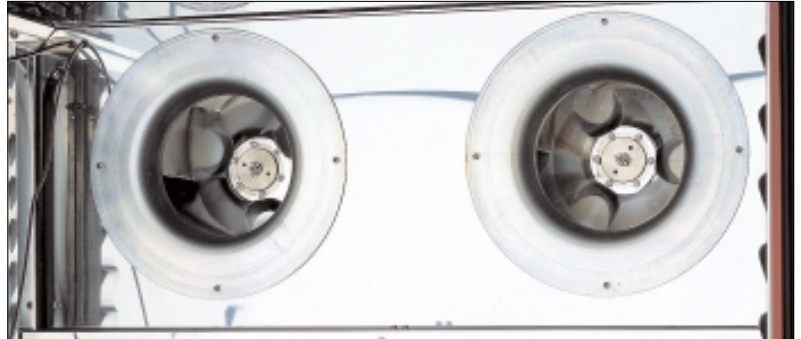



Construction features and function principle

The beautifully designed outer casing is made of corrosion-resistant, galvanized sheet steel with an environmentally friendly coating. The test chamber door is hinged on the left and has optimum contact pressure when closed.

The machine unit with the large cooling units is located underneath the test chamber in a maintenance-friendly position. The entire power electronics is located in a switch cabinet at the back of the test chamber. Every electronic function circuit has its own safety mechanism which switches off the relevant function circuit and/or the entire test chamber when faults occur.

The test space is made of high-gloss polished, high-quality stainless steel and is vapor-tight welded. The evaporator, heating elements and the large ventilation equipment with external drive motors are installed behind the conduit which is at the back of the test space. A special air ductwork system together with the enhanced temperature conditioning systems ensures quick and even temperature conditioning of the specimens.

The test chamber is equipped with separate sensors to protect the specimens irrespective of the temperature control system. Additional ducts in the side panels are provided for the electrical connections of the specimens from the outside.

The temperature conditioning system of the WK series is also equipped with humidification and dehumidification equipment with a humidity sensor. The humidity sensor is located in front of the specimens in the air stream together with the control sensor for the temperature.

Standard version

- Low/high temperature safety cutout as per EN 60519-2 (1993) with separate sensor, thermal safety class 2
- Touch panel – adjustable in height
- Parallel printer interface for HP deskjet color and EPSON printer
- Serial interface RS 232 C
- 4 potential-free switching inputs and outputs
- Contactless switching of heating elements
- 50 mm entry port in the left and 125 mm Ø in the right side panel
- Loose grid
- Water-cooled condensers

Additional features for WK series

- SIMCON/32*** is also equipped with a humidity calculator and an integrated threshold value monitoring system for humidity.
- Low water indicator
- Special temperature conditioning system in the climate working range for high temperature and humidity constancy.
- Psychrometric humidity measurement with automatic humidification.

Options

- Notebook operating station with color display mounted on a swivel arm
- HP deskjet color printer or EPSON black/white
- Software package **SIMPATI*** for Windows 98/ME, Windows NT 4.0/2000/XP Prof.
- Additional potential-free switching inputs and outputs
- Measured data recording system for Pt 100 and voltage signals ± 10 V
- Configuration modules for interface standards e.g. RS 422, RS 485, IEEE 488.2 and optical waveguide
- Mobile version
- Analog outputs for set and actual values
- Additional Pt 100-sensor/thermal elements
- Door with window
- Door with window and reach-through openings
- Fresh air purge system
- Entry ports 50 mm, 80 mm, 125 mm Ø
- Other mains supplies and frequencies
- Air-cooled condenser
- Protection against condensation with dehumidifier for avoiding condensate on the specimens
- Sound insulation
- Notches

Additional features of WK series

- Dewpoint extension in the climate range
- Capacitive humidity measurement

Further options and special accessories on request.



... Operation and Documentation

... convenient and stress-free operation

The touch panel for defining the program is on the left side of the door. It can be adjusted to the height of the operating personnel and is removable.

The operating interface with a resolution of 320 x 240 Pixel is menu-guided for the input of constant and program operation with representation of the set and actual values as graphs, the operating time and remaining number of cycles etc. including help functions.

The created programs are imported into the measurement and control system **SIMCON/32***.

SIMCON/32* is a self-monitoring, digital 32 bit measurement and control system and is responsible for all functions required for control. The highly efficient software SPS monitors and coordinates all functions and provides information on interruptions in operation.

The program memory can store a max. of 100 programs which are simple to create and store. Connection to a host computer system is possible via the serial interface RS 232 C.

The possibility to operate the system using a "laptop" is also available as an option.

The system is compatible with the simulation management software **SIMPATI***.



... SIMPATI* software – the optimum choice

SIMPATI*

SIMPATI*, the computer-aided simulation management software provides complete documentation and evaluation represented in the form of a graph. Installed on the optional notebook operating station, the user has access to the full PC performance potential.

This means controlling the test sequence, storing measured data, creating comfortable test programs with the graphics editor and printing the measured data in the form of a graph and copying in other programs for evaluation purposes. Max. 32 systems can be networked.

Thanks to an internal interface, the software is compatible with Microsoft Word, Microsoft Paint, Microsoft Excel, National Instruments Labview and special user software.

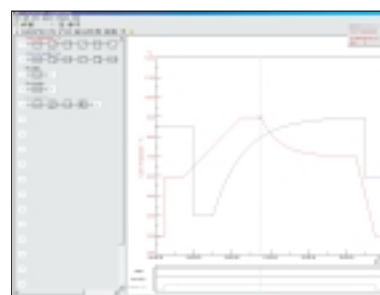
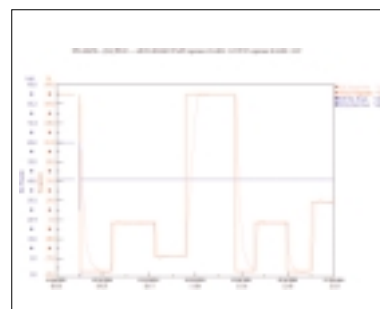

ES

Technical data . . .

Stress Screening Systems

Type			WT11/ WK11		5 K/min									
			Litres	180/ 40/5	180/ 70/5	340/ 40/5	340/ 70/5	600/ 40/5	600/ 70/5	1000/ 40/5	1000/ 70/5	1500/ 40/5	1500/ 70/5	
Test space contents			Litres	190	190	335	335	600	600	990	990	1540	1540	
Test space dimensions	Height	mm	750	750	750	750	950	950	950	950	950	950	950	
	Width	mm	580	580	580	580	800	800	1100	1100	1100	1100	1100	
	Depth	mm	450	450	765	765	800	800	950	950	1475	1475	1475	
Outside dimensions	Height	mm	1780	1780	1780	1780	1980	1980	1980	1980	1980	1980	1980	
	Width	mm	865	865	865	865	1085	1085	1385	1385	1385	1385	1385	
	Depth	mm	1280	1280	1595	1595	1655	1655	1850	1850	2375	2375	2375	
Performance for temperature tests														
Temperature range			°C	-40	-70	-40	-70	-40	-70	-40	-70	-40	-70	
Change rate			K/min	+180	+180	+180	+180	+180	+180	+180	+180	+180	+180	
as per IEC (1)	Cooling	K/min	8.0	7.5	6.8	6.7	6.5	6.0	6.7	6.0	6.3	5.0		
	Heating	K/min	7.0	7.5	6.5	6.8	6.0	6.0	6.1	6.1	6.0	6.0		
Heat compensation	at +20 °C	W	4000	3000	4000	3000	5000	5000	5000	5000	5000	5000		
	at -20 °C	W	1500	3000	1500	3000	2000	5000	2000	5000	2000	5000		
Temperature fluctuation			K	±0.1 to ±0.5 in time, ±0.5 to ±2.0 spatial										
Calibration values				+23 °C and +80 °C										
Performance for climatic tests				only WK										
Temperature range			°C	+10 to +95										
Dewpoint range			°C	-3 to +94										
Humidity range			% r. h.	10 to 98										
Humidity fluctuation			% r. h.	±1 to ±3 in time										
Temperature fluctuation			K	±0.1 to ±0.3 in time, ±0.5 to ±1.0 spatial										
Heat compensation (2)			W	400	400	400	400	500	500	500	500	500	500	
Calibration values				+23 °C / 50 % r. h. and +95 °C / 50 % r. h.										
Electrical connection				3/N/PE AC, 400 V ±10 %, 50 Hz										
Max. connected load			kW	7.5	10	7.5	10	11	16	23	26	23	26	
Max. current consumption			A	17	21	17	21	19	29	33	38	33	38	
Sound pressure level - 1 m from the front (3)			dB(A)	61	64	61	64	66	69	72	73	72	73	
Cooling water consumption (4) max.			m³/h	1.9	1.4	1.9	1.4	2.7	2.1	3.5	3.0	3.5	3.0	
Weight			kg	420	460	460	570	650	725	940	1100	1050	1250	

Performance data refer to +25 °C ambient temperature

(1) Change rate as per IEC 60068-3-5, measured in the supply air stream

(2) At +25 °C to +90 °C, humidity to max. 90 % r. h.

(3) Free field measurement as per DIN 45635, Part 1, accuracy class 2

(4) At a cooling water temperature of +28 °C and temperature difference of 5 K, water temperature +12 °C to +28 °C.

We reserve the right to make any technical alterations.

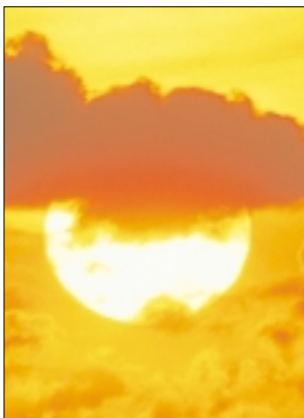

10 K/min							
270/ 40/10	270/ 70/10	480/ 40/10	480/ 70/10	800/ 40/10	800/ 70/10	1300/ 40/10	1300/ 70/10
270	270	480	480	810	810	1340	1340
750	750	920	920	920	920	920	920
580	580	800	800	1100	1100	1100	1100
620	620	650	650	800	800	1325	1325
1780	1780	1980	1980	1980	1980	1980	1980
865	865	1085	1085	1385	1385	1385	1385
1895	1895	2480	2480	2680	2680	3205	3205
-40	-70	-40	-70	-40	-70	-40	-70
+180	+180	+180	+180	+180	+180	+180	+180
12.5	14.5	12.5	11.0	12.0	12.0	11.5	10.5
10.0	10.0	10.0	10.0	12.0	12.0	12.0	11.0
6000	6000	8000	8000	8000	8000	8000	8000
2000	6000	3000	8000	3000	8000	3000	8000
±0.3 to ±0.8 in time, ±0.5 to ±2.0 spatial +23 °C and +80 °C							
only WK							
+10 to +95							
-3 to +94							
10 to 95							
±1 to ±3 in time							
±0.2 to ±0.5 in time, ±0.5 to ±1.0 spatial							
400	400	500	500	500	500	500	500
+23 °C / 50 % r. h. and +95 °C / 50 % r. h.							
3/N/PE AC, 400 V ±10 %, 50 Hz							
8	14	16	20	28	34	28	34
17	26	31	33	41	50	41	50
68	73	72	73	73	73	73	73
3.6	2.7	3.4	4.3	4.2	5.5	4.2	5.5
560	820	900	1050	1450	1600	1550	1850

15 K/min							
270/ 40/15	270/ 70/15	480/ 40/15	480/ 70/15	800/ 40/15	800/ 70/15	1300/ 40/15	1300/ 70/15
270	270	480	480	810	810	1340	1340
750	750	920	920	920	920	920	920
580	580	800	800	1100	1100	1100	1100
620	620	650	650	800	800	1325	1325
1780	1780	1980	1980	1980	1980	1980	1980
865	865	1085	1085	1385	1385	1385	1385
1895	1895	2480	2480	2680	2680	3205	3205
-40	-70	-40	-70	-40	-70	-40	-70
+180	+180	+180	+180	+180	+180	+180	+180
16.0	18.0	18.0	15.0	18.0	15.5	17.0	14.5
16.0	17.0	16.0	17.0	16.0	16.0	16.0	16.0
8000	8000	8000	8000	8000	8000	8000	8000
3000	8000	3000	8000	3000	8000	3000	8000
±0.3 to ±0.8 in time, ±0.5 to ±2.0 spatial +23 °C and +80 °C							
only WK							
+10 to +95							
-3 to +94							
10 to 95							
±1 to ±3 in time							
±0.2 to ±0.5 in time, ±0.5 to ±1.0 spatial							
400	400	500	500	500	500	500	500
+23 °C / 50 % r. h. and +95 °C / 50 % r. h.							
3/N/PE AC, 400 V ±10 %, 50 Hz							
12	16	18	24	35	44	35	44
20	31	25	43	51	63	51	63
70	73	72	73	73	73	73	73
4.6	2.7	4.0	5.5	7.0	8.0	7.0	8.0
560	835	950	1100	1500	1700	1650	1950



Test systems for professionals. Test the best . . .



A complete line of systems is available offering test space volumes ranging from approx. 60l to 1,500 litres, a working range from $-75 \dots +180^\circ\text{C}$ and relative humidity values ranging from 10...98% r.h.

We also offer an extensive line of field-proven test systems specially for simulating exposure to weather, temperature shock, corrosion and long-time tests for application in research, development, quality control and production.

Of course, Weiss – as one of the leading producers of environmental simulation systems world-wide – offers the entire spectrum of high-tech test systems starting from a series of cost-effective test systems up to customized walk-in chambers and in-line systems.

If it's know-how, service and reliability that you are looking for – contact Weiss Umwelttechnik.



Technical Sales Offices

Berlin
13407 Berlin-Reinickendorf • Flottenstrasse 58
Tel. (0 30) 40 99 05-10 • Fax (0 30) 40 99 05-50
eMail: berlin@wut.com

Hamburg
22459 Hamburg-Niendorf • Sperberhorst 6
Tel. (0 40) 68 59 96 • Fax (0 40) 68 52 91
eMail: hamburg@wut.com

Hannover
30853 Langenhagen • Walsroder Strasse 149
Tel. (05 11) 7 28 19-10 • Fax (05 11) 7 28 19-30
eMail: hannover@wut.com

Oberhausen
46045 Oberhausen • Mülheimer Strasse 48
Tel. (02 08) 6 20 65-10 • Fax (02 08) 6 20 65-20
eMail: oberhausen@wut.com

Stuttgart
70567 Stuttgart-Möhringen • Zettachring 10
Tel. (07 11) 90 02 45-10 • Fax (07 11) 90 02 45-30
eMail: stuttgart@wut.com

Nürnberg
90592 Schwarzenbruck • Robert-Bosch-Strasse 15
Tel. (0 91 28) 92 37 55 • Fax (0 91 28) 92 37 65
eMail: nuernberg@wut.com

München
82166 Gräfelfing • Wandlhamer Strasse 31
Tel. (0 89) 89 80 45-10 • Fax (0 89) 89 80 45-30
eMail: muenchen@wut.com

Leipzig
04105 Leipzig • Tschalkowskistrasse 14
Tel. (03 41) 9 84 57-10 • Fax (03 41) 9 84 57-30
eMail: leipzig@wut.com

Subsidiaries

Weiss Umwelttechnik Ges.m.b.H.
A-1232 Wien • Ober-Laaer Strasse 316
Tel. (01) 6 16 66 97 • Fax (01) 6 16 66 97-13
weiss.umwelttechnik-wien@schunk-group.com

Weiss Technik Belgium B.V.B.A.
B-1770 Liedekerke
Nijverheidszone • Begijnenmeers 63
Tel. (0 53) 68 10 10 • Fax (0 53) 68 10 20
e-Mail: sales@weissstechnik.be

Weiss Technik AG
CH-8802 Kilchberg • Böndlerstrasse 29
Tel. (01) 7 16 10 66 • Fax (01) 7 16 10 76
e-Mail: info@weiss-technik.ch

Weiss Technik France E.U.R.L.
F-78955 Carrières sous Poissy
283, route d'Andrésy
F-78304 Poissy Cedex • B.P. 4015
Tel. (1) 34 01 11 00 • Fax (1) 39 75 11 00
eMail: info@weissfr.com

Weiss Technik Ltd.
GB-Coleshill • Buckinghamshire HP7 OLS
The Old School House • Luckings Estate
Tel. (0 14 94) 43 43 24 • Fax (0 14 94) 43 43 25
eMail: info@weissstechnik.co.uk

Weiss Technik Italia S.r.l.
I-20013 Magenta (Mi) • Via Murri, 22 – 28
Tel. (02) 97 29 16 16 • Fax (02) 97 29 16 18
eMail: info@weissitalia.it

Weiss Enet Indusrieteknik B.V.
NL-4004 JP Tiel • Morsestraat 8
Tel. (03 44) 67 04 00 • Fax (03 44) 67 04 05
eMail: info@weissenet.nl

Weiss Environmental Technology Inc.
Menomonee Falls, WI 53051, USA
W146 N9300 Held Drive
Tel. (2 62) 2 53-87 30 • Fax (2 62) 2 55-13 91
eMail: info@schunkgraphite.com

5.01



Weiss Umwelttechnik GmbH Simulationsanlagen • Messtechnik

35447 Reiskirchen-Lindenstruth/Germany • Greizer Str. 41–49
Telefon (0 64 08) 84-0 • Telefax (0 64 08) 84-87 10
Internet: www.wut.com • eMail: info@wut.com

D-Nr. TP 1.5E/55025-54025